

# NBC-M12FRY/5,0-94H - Hybrid cable



1146412

<https://www.phoenixcontact.com/us/products/1146412>

Please be informed that the data shown in this PDF document is generated from our online catalog. Please find the complete data in the user documentation. Our general terms of use for downloads are valid.



Hybrid cable, Ethernet hybrid CAT5 (100 Mbps), 8-position, PUR halogen-free, black RAL 9005, shielded (Tinned copper braided shield), Socket angled M12, coding: Y / IP65/IP67, on free cable end, cable length: 5 m, Power with Ethernet (PWE)

## Commercial data

Item number	1146412
Packing unit	1 pc
Minimum order quantity	1 pc
Sales key	BF04
Product key	BF1CML
GTIN	4063151137618
Weight per piece (including packing)	587 g
Weight per piece (excluding packing)	22.22 g
Customs tariff number	85444290
Country of origin	PL

# NBC-M12FRY/5,0-94H - Hybrid cable



1146412

<https://www.phoenixcontact.com/us/products/1146412>

## Technical data

### Product properties

Product type	Data cable preassembled
Sensor type	Ethernet hybrid
Number of positions	8
Application	Standard
No. of cable outlets	1
Shielded	yes
Coding	Y

### Interfaces

Bus system	Ethernet
Signal type/category	Ethernet hybrid CAT5 (IEC 11801), 100 Mbps

### Signaling

Status display	No
Status display present	No

### Electrical properties

Nominal voltage $U_N$	48 V AC (Power and data)
	50 V DC (Power and data)
Nominal current $I_N$	6 A (Power)
	0.5 A (Data)
Transmission medium	Copper

### Material specifications

Flammability rating according to UL 94	V0
--	----

### Connector

#### Connection 1

Type	Socket angled M12 / IP65/IP67
Number of positions	8 (4+4)
Coding type	Y (Hybrid)
Shielded	yes
Handle color	black
Material	CuZn (Contact)
	Ni/Au (Contact surface)
	PA (Contact carrier, data)
	PA (Contact carrier, power)
	TPU, hardly inflammable, self-extinguishing (Grip)
Zinc die-cast, nickel-plated (Screw connection)	
Insertion/withdrawal cycles	≥ 100

# NBC-M12FRY/5,0-94H - Hybrid cable



1146412

<https://www.phoenixcontact.com/us/products/1146412>

Insulation resistance	≥ 100 MΩ
Tightening torque	0.4 Nm
Degree of protection	IP65/IP67
Ambient temperature (operation)	-25 °C ... 90 °C

## Connection 2

Type	free cable end
------	----------------

## Cable/line

Cable length	5 m
--------------	-----

## Ethernet hybrid [94H]

Dimensional drawing	
Cable weight	110 kg/km
UL AWM Style	20233 (80°C/300 V)
Number of positions	8
Shielded	yes
Cable type	Ethernet hybrid [94H]
Conductor structure	1x4x AWG 26+1x4x AWG 18
Conductor structure signal line	19x 0.10 mm
AWG signal line	26
Conductor cross section	4x 0.15 mm <sup>2</sup> (Data) 4x 0.85 mm <sup>2</sup> (Power)
Wire diameter incl. insulation	1.05 mm (Data) 1.4 mm (Power)
External cable diameter	8.80 mm ±0.2 mm
Outer sheath, material	PUR
External sheath, color	black RAL 9005
Conductor material	Bare Cu litz wires
Material wire insulation	PP (Data) PP (Power)
Single wire, color	white/orange, orange, white/green, green, white, blue, brown, black
Overall twist	1 star quad and 4 wires with 2 fillers
Optical shield covering	85 %
Insulation resistance	≥ 5 GΩ*km
Loop resistance	≤ 280.00 Ω/km (Data) ≤ 45.00 Ω/km (Power)

# NBC-M12FRY/5,0-94H - Hybrid cable



1146412

<https://www.phoenixcontact.com/us/products/1146412>

Wave impedance	100 $\Omega$ $\pm$ 15 $\Omega$ (4 MHz ... 100 MHz)
Working capacitance	nom. 50 nF (per kilometer)
Differential impedance	100 $\Omega$ $\pm$ 5 % (at 100 MHz)
Nominal voltage, cable	$\leq$ 125 V (Peak value, not for high-power applications)
Test voltage Core/Core	2000 V (50 Hz, 1 min.)
Test voltage Core/Shield	2000.00 V (50 Hz, 1 min.)
Minimum bending radius, fixed installation	4 x D
Minimum bending radius, flexible installation	8 x D
Smallest bending radius, fixed installation	36 mm
Smallest bending radius, movable installation	71 mm
Max. bending cycles	2000000
Tensile strength	85 N (in accordance with DIN EN 50565-1 for flexible installation) 295 N (in accordance with DIN EN 50565-1 for fixed installation)
Near end crosstalk attenuation (NEXT)	56.3 dB (at 4 MHz) 50.3 dB (at 10 MHz) 47.2 dB (at 16 MHz) 45.8 dB (at 20 MHz) 42.9 dB (at 31.25 MHz) 38.4 dB (at 62.5 MHz) 35.3 dB (at 100 MHz)
Shield attenuation	6.2 dB (at 4 MHz) 9.8 dB (at 10 MHz) 12.4 dB (at 16 MHz) 13.9 dB (at 20 MHz) 17.6 dB (at 31.25 MHz) 25.4 dB (at 62.5 MHz) 32.8 dB (at 100 MHz) $\geq$ 80.00 dB (30 MHz ... 100 MHz)
Halogen-free	according to IEC 60754-1 in accordance with DIN VDE 0472 part 815
Flame resistance	in accordance with UL 1581, Section 1060 in acc. with UL 1581, section 1061 in accordance with UL 2556, Section 9.3
Resistance to oil	in accordance with IEC 60811-404 According to DIN EN 50363-10-2
Other resistance	Low adhesion Hydrolysis resistance (DIN EN 50396)
Special properties	Free of substances which would hinder coating with paint or varnish Silicone-free
Ambient temperature (operation)	-40 $^{\circ}$ C ... 80 $^{\circ}$ C (cable, fixed installation) -30 $^{\circ}$ C ... 70 $^{\circ}$ C (Cable, flexible installation)

## Environmental and real-life conditions

# NBC-M12FRY/5,0-94H - Hybrid cable



1146412

<https://www.phoenixcontact.com/us/products/1146412>

## Ambient conditions

Degree of protection	IP65
	IP67
	IP65/IP67

## Standards and regulations

Standard designation	M12 connector
Standards/specifications	IEC 61076-2-113

# NBC-M12FRY/5,0-94H - Hybrid cable

1146412

<https://www.phoenixcontact.com/us/products/1146412>

## Drawings

Circuit diagram

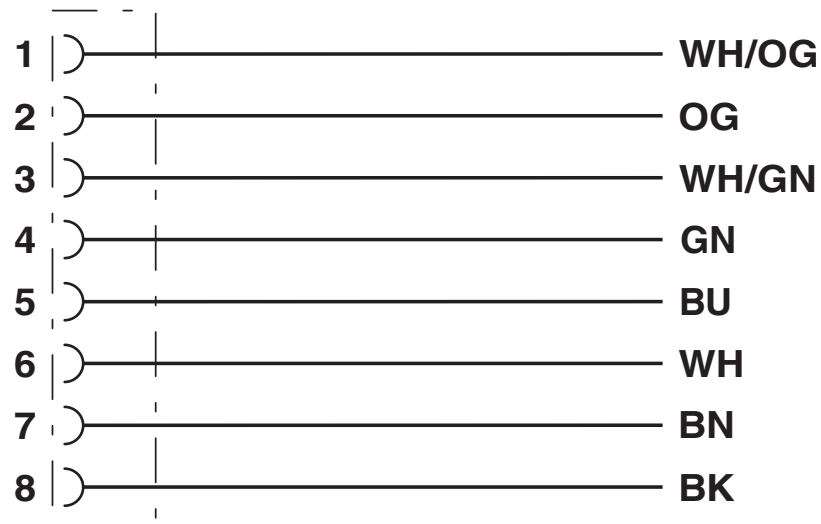

Dimensional drawing

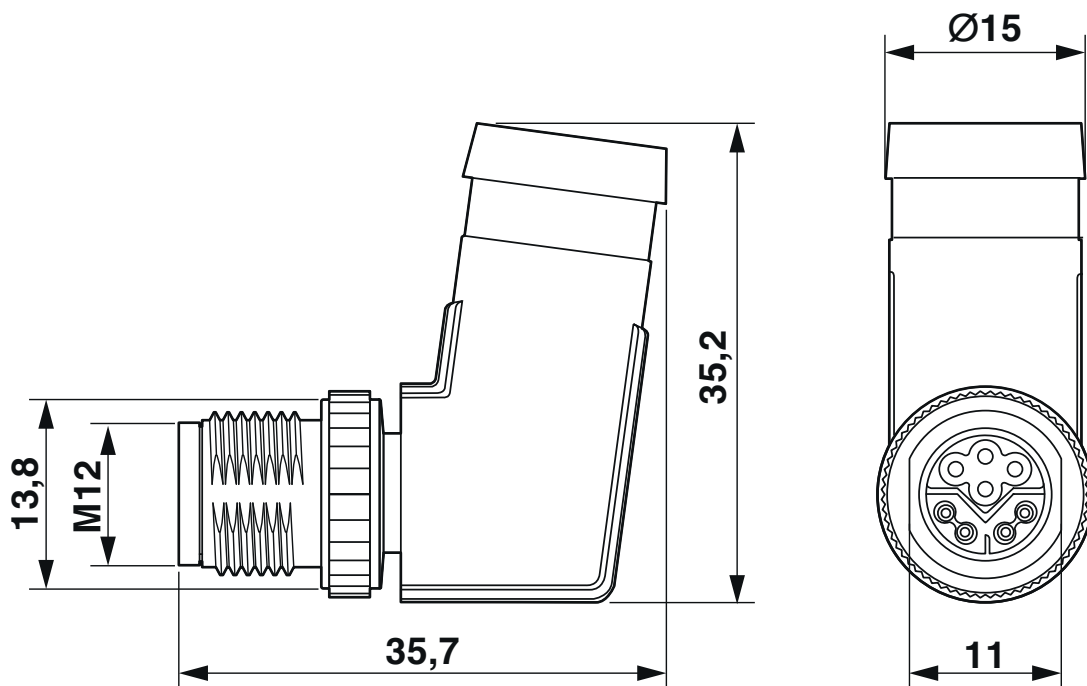

M12 x 1 socket, angled, shielded

# NBC-M12FRY/5,0-94H - Hybrid cable

1146412

<https://www.phoenixcontact.com/us/products/1146412>

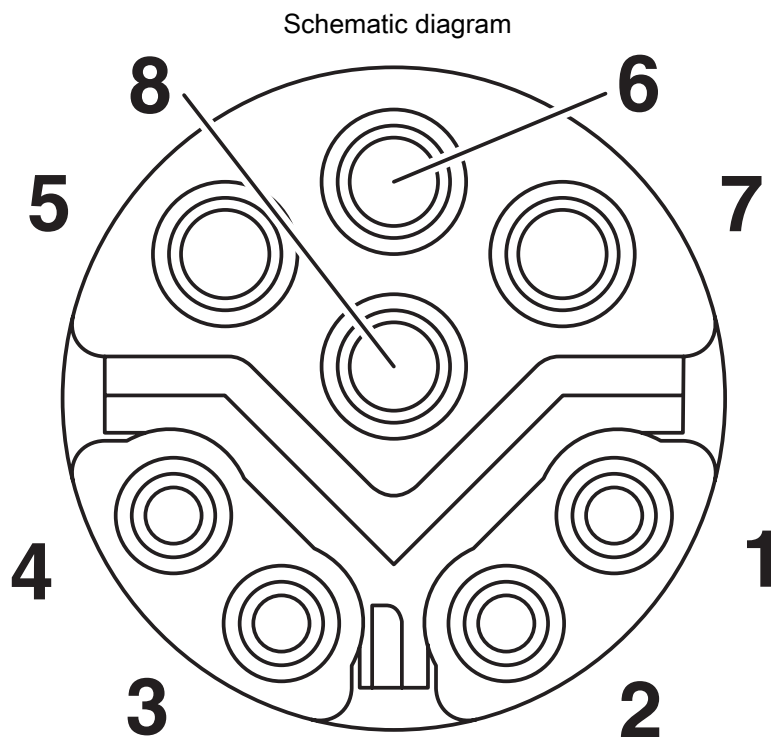

M12 hybrid plug pin assignment, 8-pos., Y-coded, socket side view

# NBC-M12FRY/5,0-94H - Hybrid cable





1146412

<https://www.phoenixcontact.com/us/products/1146412>

## Approvals

To download certificates, visit the product detail page: <https://www.phoenixcontact.com/us/products/1146412>

 <b>UL Listed</b> Approval ID: FILE E 335024				
	Nominal voltage $U_N$	Nominal current $I_N$	Cross section AWG	Cross section $\text{mm}^2$
	56.5 V	0.175 A	-	-

 <b>cUL Listed</b> Approval ID: FILE E 335024				
	Nominal voltage $U_N$	Nominal current $I_N$	Cross section AWG	Cross section $\text{mm}^2$
	56.5 V	0.175 A	-	-

 <b>cUL Listed</b> Approval ID: E221474				
	Nominal voltage $U_N$	Nominal current $I_N$	Cross section AWG	Cross section $\text{mm}^2$
Power	48 V	6 A	-	-
Data	50 V	0.5 A	-	-

 <b>UL Listed</b> Approval ID: E221474				
	Nominal voltage $U_N$	Nominal current $I_N$	Cross section AWG	Cross section $\text{mm}^2$
Power	48 V	6 A	-	-
Data	50 V	0.5 A	-	-

# NBC-M12FRY/5,0-94H - Hybrid cable



1146412

<https://www.phoenixcontact.com/us/products/1146412>

## Classifications

### ECLASS

ECLASS-11.0	27060307
ECLASS-12.0	27060307
ECLASS-13.0	27060307

### ETIM

ETIM 9.0	EC001855
----------	----------

### UNSPSC

UNSPSC 21.0	26121600
-------------	----------

# NBC-M12FRY/5,0-94H - Hybrid cable



1146412

<https://www.phoenixcontact.com/us/products/1146412>

## Environmental product compliance

China RoHS	Environmentally friendly use period: unlimited = EFUP-e
	No hazardous substances above threshold values

# NBC-M12FRY/5,0-94H - Hybrid cable



1146412

<https://www.phoenixcontact.com/us/products/1146412>

## Accessories

### PROT-M12 MS-PA-CHAIN - Screw plug

1430899

<https://www.phoenixcontact.com/us/products/1430899>

M12 sealing cap with fixing band, for sensor cables, for free M12 sockets



---

### SAC-M12-EXCLIP-F - Locking clip

1558991

<https://www.phoenixcontact.com/us/products/1558991>

Locking clip for the socket side of sensor/actuator cables with M12 connector and M12 connectors for assembly, for knurl diameter: 15 mm or for Allen key with a wrench size of 14 mm, prevents the disconnection of plug-in connections without tools



# NBC-M12FRY/5,0-94H - Hybrid cable



1146412

<https://www.phoenixcontact.com/us/products/1146412>

## TSD 04 SAC - Torque screwdriver

1208429

<https://www.phoenixcontact.com/us/products/1208429>



Torque screwdriver, with preset torque of 0.4 Nm and 4 mm hexagonal drive for M12 connectors

---

## TSD-M 1,2NM - Torque screwdriver

1212224

<https://www.phoenixcontact.com/us/products/1212224>



Torque screw driver, accuracy as per EN ISO 6789 standard, adjustable from 0.3 - 1.2 Nm

# NBC-M12FRY/5,0-94H - Hybrid cable



1146412

<https://www.phoenixcontact.com/us/products/1146412>

## TSD-M SAC-BIT ADAPTER - Adapter insert

1212600

<https://www.phoenixcontact.com/us/products/1212600>



Adapter bit for TSD-M...torque tools, E6.3-1/4" drive with 4 mm hexagon to accommodate SAC bits

## SAC BIT M12-D15 - Tool

1208432

<https://www.phoenixcontact.com/us/products/1208432>



Nut for assembling sensor/actuator cables with M12 connector and M12 connectors for assembly, with a knurl diameter of 15 mm, for 4 mm hexagonal drive

Phoenix Contact 2024 © - all rights reserved  
<https://www.phoenixcontact.com>

Phoenix Contact USA  
586 Fulling Mill Road  
Middletown, PA 17057, United States  
(+717) 944-1300  
[info@phoenixcon.com](mailto:info@phoenixcon.com)